



G25 and G40

Diaphragm Meters

Through decades of knowledge in the field of commercial and industrial diaphragm gas meters, our G25 and G40 meter sizes combine accuracy of measurement and long life in the field.

KEY BENEFITS

- » Ready for remote reading and data management
- » Long-term accuracy and reliability
- » Very low pressure loss
- » Robust, maintenance-free meter
- » Large cyclic volumes

APPLICATION

The G25-G40 diaphragm meters are used for applications requiring high precision and large rangeability at low pressure (below 1 bar gauge).

Due to the volumetric principle of the diaphragm meter, its metrology is not influenced by installation conditions.

They are designed for use with natural gas, manufactured gas and other non-corrosive gases.

The G25-G40 diaphragm meters are approved for fiscal use.

OPERATING PRINCIPLE

The movement of the diaphragm is caused by the pressure difference between the inlet and the outlet of the meter. The reciprocal filling is controlled by means of 2 sliding valves.

This oscillating movement is transformed into a rotational one and is mechanically transmitted to the totalizer through a magnetic coupling or a stuffing box.

TYPICAL ERROR CURVE

G25 (Two Pipe DN50)

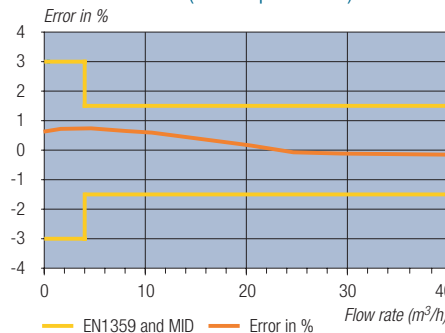

G40 (Two Pipe DN80)

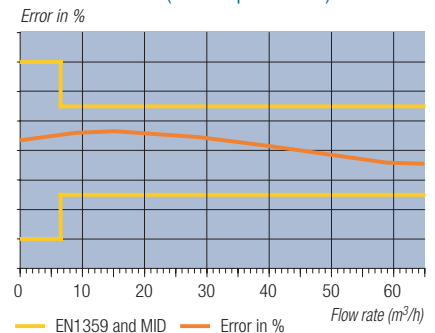

PRESSURE LOSS CURVE

G25

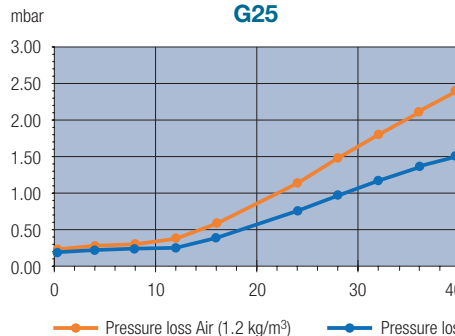

G40

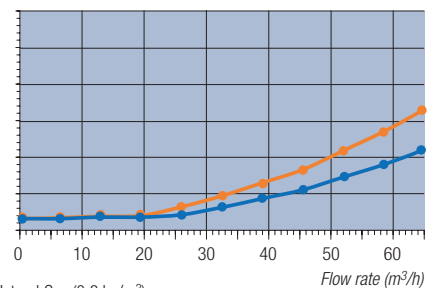

CONSTRUCTION

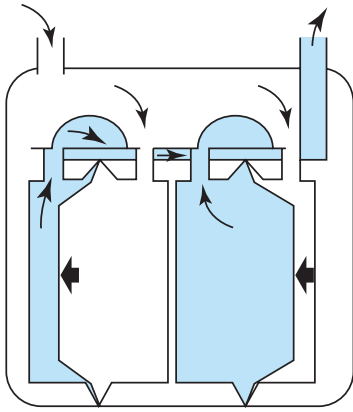

Working Principle



Measuring Unit

A diaphragm meter is made of four main parts:

- 1 The measuring unit mainly consisting in:
 - » Four measuring chambers.
 - » Two sliding valves.
 - » An outlet pipe.
- 2 A steel casing where 1 or 2 connectors are fitted.
- 3 A magnetic coupling or a stuffing box transmits the movement of the measuring unit to the totalizer.
- 4 A totalizer is available in different versions depending on the application

Technical Specifications

Gas Type	Natural Gas, air, propane, butane, nitrogen and all non-corrosive gases		
Cyclic Volume	G25:	20 dm ³	
	G40:	30 dm ³	
Temperature Range	Ambient:	-25°C to +55°C	
	Gas:	-25°C to +55°C	
	Storage:	-40°C to +70°C	
Maximum Working Pressure	0.5 bar (1 bar optional)		
Flow Range	G25:	Qmin	0.25 m ³ /h
		Qmax	40 m ³ /h
	G40:	Qmin	0.4 m ³ /h
		Qmax	65 m ³ /h
Accuracy	Class 1.5		
Approval	MID (04/22/EC) module B, DE-10-MI002-PTB004 Rev.1, and EN1359:1998 + A1:2006		
Metrology	In accordance with the EN1359:1998/A1:2006 and MID Maximum permissible errors are +/-3% from Qmin to 0.1 Qmax and +/-1.5% from 0.1 Qmax to Qmax.		
Totalizer	IP54 UV resistant cover Fitted with a reflecting disc on the first drum to facilitate periodical checks Customised name plate: bar code, customer serial number or logo		
Magnetic Coupling Stuffing Box Connections	The meter is equipped as standard with a magnetic coupling As an alternative a stuffing box can be also installed Single pipe or 2 pipe connections From DN40 to DN80 depending on the G-size Vertical connections for the G25, vertical or horizontal for the G40 Other connections are available on request		
Backrun Stop	Prevents the meter from running backwards in case of tampering		
Materials	Steel sheet, drawn or welded depending on the G-size. The use of a powder-coated painting guarantees long term protection against corrosion. All the casings are of a screw type to allow easy maintenance on the meter – no crimped casing		
Colour	Light grey RAL7035		

Options

Thermowell	The meters can be fitted with a thermowell to allow electronic temperature compensation. A second thermowell for reference measurements is available on special request
High Temperature Loading (HTL)	The meters can be delivered in a HTL version following EN1359 PN0,1
Pressure Tapping	This device allows the gas pressure to be measured at a reference point.



Thermowell fitted onto an ACD standard

TOTALIZER FEATURES

With the ECO series, Itron offers a complete portfolio to address today's and future energy resource and environmental challenges.

"e" series

Supporting the prevailing European Communication

Standards and ensuring interoperability

This smart meter equipped with an electronic index is designed to facilitate integration into wired and wireless fixed networks and has built-in communications capabilities which detects reversed operation, magnetic tampering and backflow.

- » High accuracy error curve correction
- » Optional temperature conversion
- » Built-in 2-way wired/wireless M-Bus communication
- » Safe data transmission with AES
- » Tamper protection and detection

"c" series

Smart ready, allowing for future AMR capabilities

Itron's latest-generation mechanical index meter comes standard with our Cyble™ target, and can be upgraded in the field to implement AMR and enable remote reading via different communication technologies.

- » Smart reading possible with additional modules
- » Can be retrofitted on site without recalibrating the meter
- » Reliable of an electronic switch (no wear or bouncing)
- » Proven, tested design backed by 20 years' experience
- » Protection against magnetic tampering

"o" series

Retrofit enabling smart upgrades to existing meter park

- » The "o" series addresses traditional meters with a mechanical index, already installed in the field, to minimize stranded assets when AMR/AMI is required. LF transmitters - via a Reed switch - and a Pulse RF radio module transform pulses into transmittable data.



"o" series Totaliser with LF "cable"

Building Blocks of Itron's ECO series



Base Meter

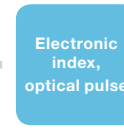

Index



Communication Module

Totalizer characteristics "e" series

Meter Size	G25
European Metrological Approval (04/22/EC - Module B)	N° DK-0200-MI002-018 Rev.5
Temperature Range	Temperature (converted): -10°C to +55°C (-25°C to +55°C) Storage temperature: -20°C to +60°C (> 55°C for up to 4 hours)
ATEX Approval	II 2G Ex ib IIB T3
Relative Humidity	Maximum 93% non-condensing between -25°C and +55°C
Display	LCD with 9 digits (3 decimals)
M-Bus Interface	300bps / 2400 bps / one bus load, wireless or dongle (up to four bus loads)
Battery	Lithium battery with an average lifetime of min. 15 years under reference conditions
Standards	EN12405-1: 2007-08, Directive 2004/108/EC (EMC) and OIML D11 (EMC), NTA8130-May 2007, DSMR V2.2+ (Netherlands)
Serial Bus	M-Bus slave (wired: EN13757-2/3, wireless: EN13757-4)
Customer Port	IR service interface (EN62056-21)
Mechanical Environment	M1
Electronical Environment	E2



Base Meter

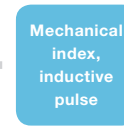

Index



Communication Module

Totalizer characteristics "c" series

Meter Size	G25 / G40
European Metrological Approval (04/22/EC - Module B)	N° DE-10-MI002-PTB004 Rev.1
Display	Mechanical index with 8 drums (2 decimals)
Transmission Rate	0.1 m³ / rotation
Transmission System	Cyble™ target
Mechanical Environment	M2
Electronical Environment	E2



Base Meter

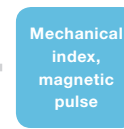

Index



Communication Module

Totalizer characteristics "o" series

Meter Size	G25 / G40
European Metrological Approval (04/22/EC - Module B)	N° DE-10-MI002-PTB004 Rev.1
Display	Mechanical index with 8 drums (2 decimals)
Pulse Generator	Standard 0.1 m³ / pulse (optional 1 m³ / pulse)
Pulse Transmitter	Retrofittable LF system, 180 Vdc max – 50 mA max standard 0.1 m³/pulse. Different versions: with 1m cable, terminal block or binder plug (Double LF pulse transmitter)
Mechanical Environment	M2
Electronical Environment	E2

Dimensions and Weight

Model	G Size	Qmax m³/h	Qmin m³/h	Cyclic Volume dm³	DN mm	Threads Standard	Pmax bar	Pmax HTL bar	Pressure Loss (Air) mbar	A mm	B mm	C mm	D mm	E mm		F mm	Weight kg	
														"e" series	"c & o" series		"e" series	"c & o" series

G25: 2 Pipe version

1	G25	40	0.25	20	50	G2½" A ISO228-1	1	0.1	2.4	335	443	138	457	304	289	-	13.7	13.3
2	G25	40	0.25	20	50	MFIT001	1	0.1	2.4	335	443	138	457	304	289	-	13.7	13.3
3	G25	40	0.25	20	40	G2" A ISO228-1	1	0.1	2.4	335	443	138	457	304	289	-	13.7	13.3
4	G25	40	0.25	20	50	G2½" A ISO228-1	1	0.1	2.4	400	534	138	457	304	289	-	13.9	13.6

G25: Single Pipe version

5	G25	40	0.25	20	50	ISO PN10	1	0.1	2.4	-	469	138	457	304	289	-	14.8	14.4
---	-----	----	------	----	----	----------	---	-----	-----	---	-----	-----	-----	-----	-----	---	------	------

G40: 2 Pipe version - vertical drawn

1	G40	65	0.4	30	65	ISO PN10	1	0.1	1.7	430	661	185	612	399	384	-	42.4	42.0
2	G40	65	0.4	30	80	ISO PN10	1	0.1	1.7	430	661	185	612	399	384	-	42.4	42.0
3	G40	65	0.4	30	80	ISO PN10	1	0.1	1.7	500	719	185	612	399	384	-	41.4	41.0
4	G40	65	0.4	30	65	ISO PN10	1	0.1	1.7	510	719	185	612	399	384	-	41.4	41.0
5	G40	65	0.4	30	80	ISO PN10	1	0.1	1.7	510	719	185	612	399	384	-	41.4	41.0

G40: 2 Pipe version - horizontal welded

6	G40	65	0.4	30	65	ISO PN10	0.5	0.1	1.7	570	420	175	494	384	369	634	52.4	52.0
7	G40	65	0.4	30	80	ISO PN10	0.5	0.1	1.7	570	420	175	494	373	358	634	52.4	52.0

G40: Single pipe version

8	G40	65	0.4	30	65	ISO PN10	1	0.1	1.7	-	697	185	612	399	384	-	46.4	46.0
9	G40	65	0.4	30	80	ISO PN10	1	0.1	1.7	-	697	185	612	399	384	-	46.4	46.0

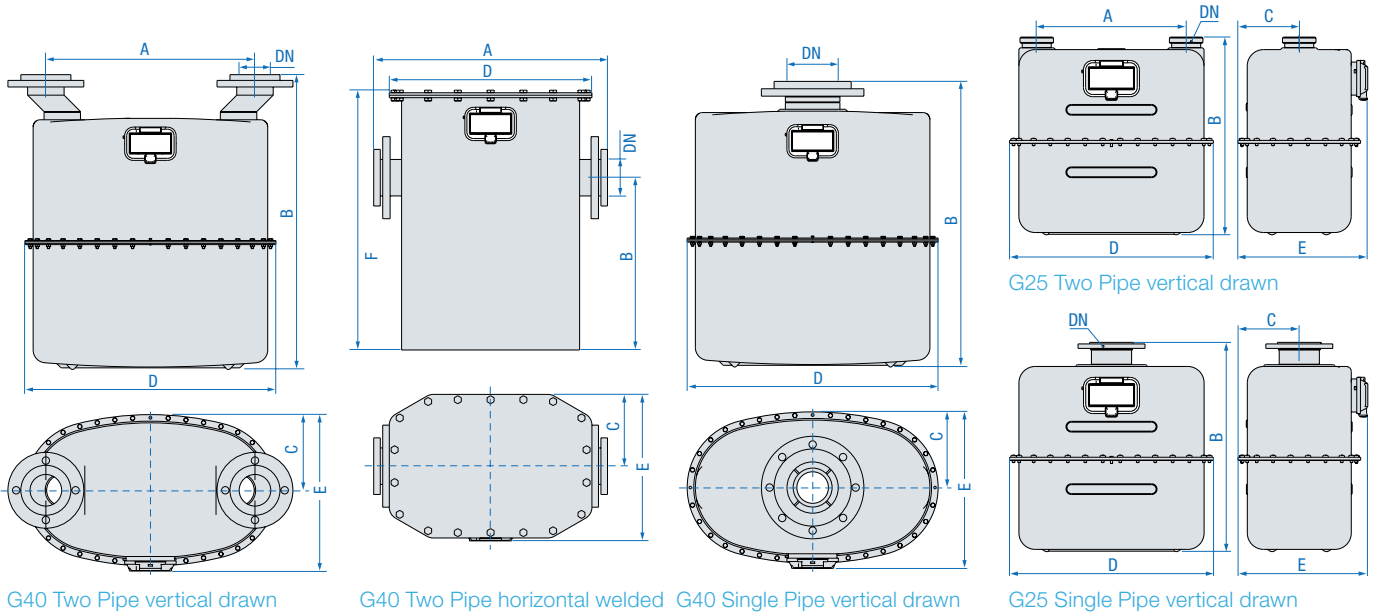

Our company is the world's leading provider of smart metering, data collection and utility software systems, with over 8,000 utilities worldwide relying on our technology to optimize the delivery and use of energy and water.

To realize your smarter energy and water future, start here: www.itron.com

For more information, contact your local sales representative or agency:

ITRON GmbH

Hardeckstraße 2
D-76185 Karlsruhe
Germany

Phone: +49-721 5981 0

Fax: +49-721 5981 189